

Comfort Telephone Users Guide

AGFEO T 15 Comfort Telephone



AGFEO
einfach | perfekt | kommunizieren

Table of Contents

Table of Contents	2
Accessories and Content	3
ComfortTelephone T 15	3
AGFEO T 15 Buttons	4
AGFEO T 15 Buttons	5
AGFEO T 15 Display	5
Installation	6
To make a call	7
On-Hook Dialling	7
Language Selection	7
Time, Date and Contrast Setting	7
Redial	8
VIP-Function	8
One-Touch Memory	9
Two-Touch Memory	10
Phonebook	11
Entering Names with Alphanumeric Keypad	12
Operation of Caller ID	13
Declaration of Conformity	14

Accessories and Content

Following items are included in the package of the AGFEO T 15 Comfort Telephone:

- Phone base unit
- Handset with coil cord
- Line cord
- AC adaptor
- This manual

ComfortTelephone T 15

1. Handset
2. Base unit
3. Key top
4. Hook switch
5. Speaker
6. New call indicator
7. LCD-display
8. Speaker phone mic
9. Coil cord
10. Line cord
11. Battery compartment
12. Jack for coil cord
13. Ringer switch
14. Adaptor Socket
15. Jack for line cord
16. Jack for headset

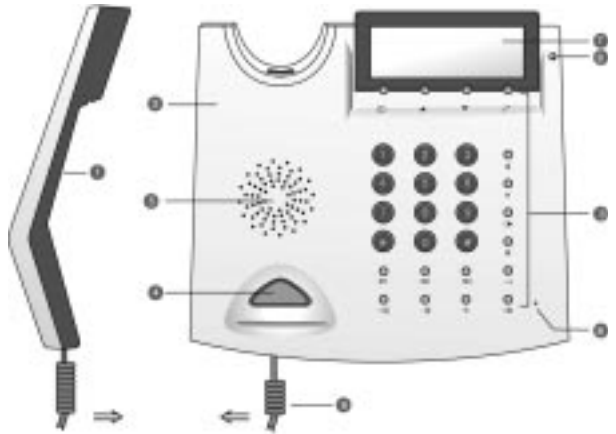







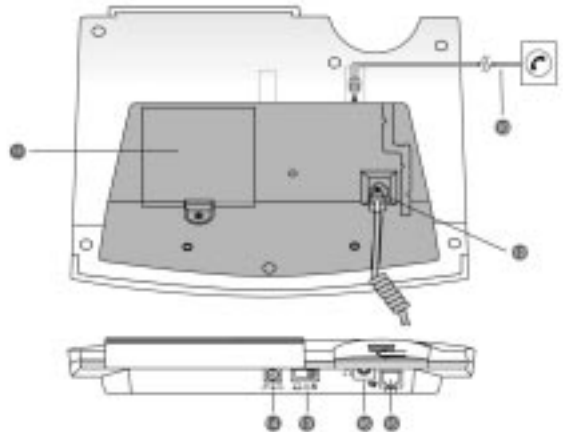



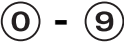

Ringer high: 

Ringer low: 

Ringer off: 



AGFEO T 15 Buttons

Function buttons	Description
	To enter the digits 0-9
	To enter *
	To enter #
	To confirm an action This button functions as CALL BACK when browsing incoming calls. Please refer to " Operation of Call Back Function " for details.
	This button functions as STORE when programming a telephone number into the Two-Touch memory. Please refer to " Two-Touch Memory " and " Phone Book " section for details.
	This button functions as "MUTE" during conversation. Press this button once and your voice will not pass through the microphone. To resume, press the button again.
	To delete an entry or a record in the memory.
	To set time, date and LCD contrast (HI/LO) for the unit.
	Flash or Recall to switch between 2 lines.
	To put your phone off-hook for on-hook dialling. To switch back, simply pick up the handset and speak as normal.
	This button functions as "Last Number Redial" when you make a call (32 digits maximum). Numbers that are longer than 32 digits will not be stored in the redial memory. This button functions as "Pause" when programming a telephone number into the phone book. It is mainly used when storing a prefix in the one- or two-touch memory. Press Pause button where the pause is needed and complete the storing process as described in "Two-Touch Memory".
M1 - M3	One-Touch memory (18 digits maximum). Push one of these keys to make a call to one of the stored telephone numbers. Please refer to instruction for users, section " One-Touch Memory ".
	Phone book function has up to 70 memory locations in the Phone Book memory. For details, please see " Phone Book " section in this user manual.

AGFEO T 15 Buttons

Function buttons	Description
▲ / ▼	To scroll up/down when browsing selections, and to move the cursor to left/right when editing a record.
+ 🔊 / - 🔊	To select the speaker volume from low to high (i.e. Level 1- Level 4)
🔇 🔔 🔔	To select ringer level (Off/Low/High)
☎	Telephone Line Jack for line cord plug in.

AGFEO T 15 Display

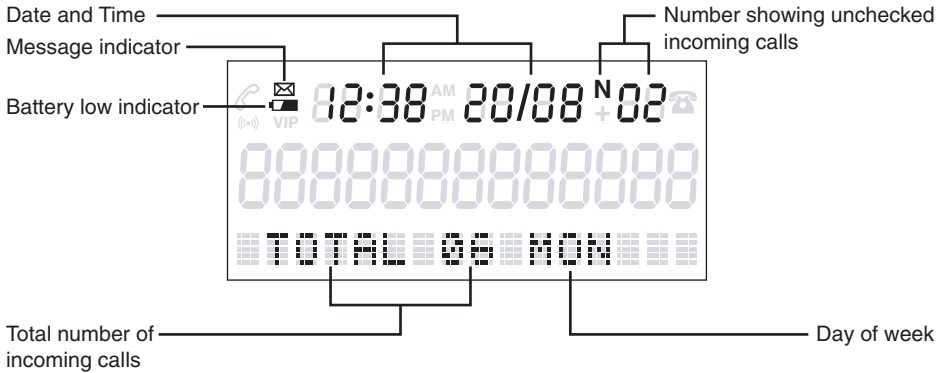

Installation



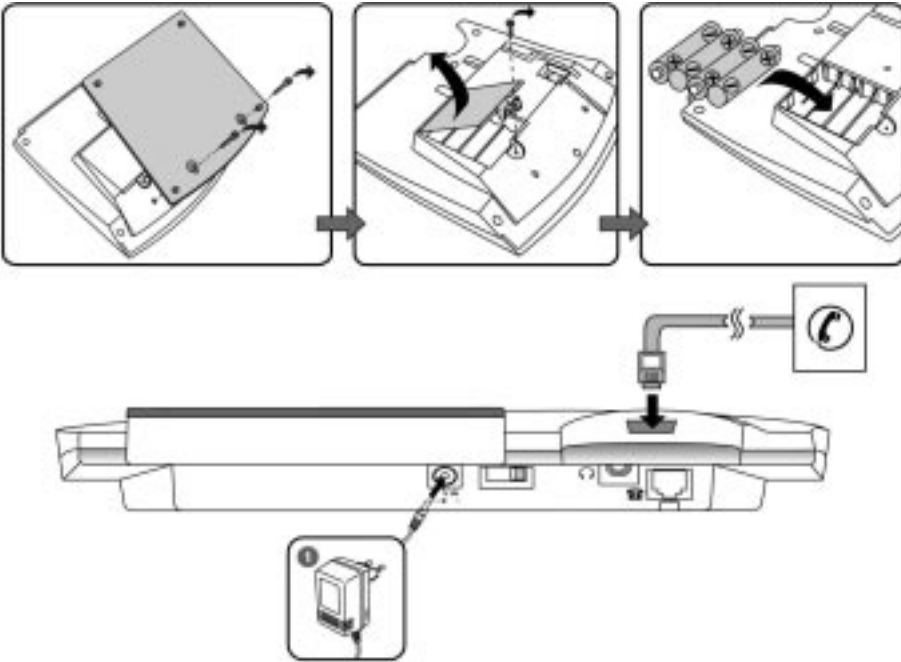

Refer to the Main Diagram section and:

1. Remove the bottom plate by unscrewing the screws.
2. Connect the coil cord to the jack on the base unit.
3. Install batteries:
 - i) Remove the battery compartment door by unscrewing the screw.
 - ii) Insert 4 fresh AA size batteries by observing the +/- polarity marks in the battery compartment.
 - iii) Replace the battery compartment cover securely.
4. Replace the bottom plate.
5. Connect one end of the line cord to the jack on the base unit, and the other end to the wall outlet for telephone.









Language Selection

In the state of On-hook, do as follows:

- Press and hold DELETE button()
- While keeping on pressing DELETE button, press and hold CALL BACK button()
- Continuous to keep DELETE and CALL BACK buttons being pressed together, press arrow up until current language setting shown on display.
- Use arrow buttons ( / ) to select the language.
- Press CALL BACK button() to confirm and exit.

Time, Date and Contrast Setting

- Press and hold SET button () until the display shows "SET TIME".
- Use arrow buttons ( / ) to select the correct number.
- Press CALL BACK button () to confirm and move to the next digit.
- Press the SET button () again, the LCD Contrast can be adjusted and "SET CONTRAST HI" will appear on the display.
- Use arrow buttons to select desired level..
- Press SET button () to exit.

Note

The Setting sequence is "Hour-Minute-Month-Day-Year-Weekday". The weekday is shown by a number in the left side of the display (1=Monday...7=Sunday). After completion, the display will show "TOTAL CALLS XX" and the name of the day.

When you receive the first incoming call, time and date will be automatically set if you have FSK Caller ID service.

To make a call

To make a call, simply pick up the handset and wait for the dialling tone. Then, dial the desired telephone number with the numeric keys.



To end a call, replace the handset onto the cradle of the base unit, or push the hook switch.

On-Hook Dialling

To Use On-Hook Dialling, you may enter the number to dial before or after pressing the SPEAKER button(). On-Hook Dialling works with phone numbers stored in phone book, one-touch memory, two-touch memory and redial list.

When the dialled number is answered, simply speak or pick up the handset to talk to the other end.

Redial

- In the state of on-hook, press CALL BACK button () once.
- Use arrow buttons to select the number you want to dial.
- Lift the handset or press the SPEAKER button (), the phone number will be dialled.
- To delete a single record, simply press DELETE button () twice. If you want to delete all records, press and hold DELETE button until the display shows "ALL DEL ?". Press DELETE button again to confirm.



Note

The call back feature will not dial the phone number if the selected call record phone number is blocked or not available.





VIP-Function

The VIP Function of your AGFEO T15 signalizes an incoming call from a preset VIP-Number with a "beep" tone.

To set a number from the Caller ID memory as VIP

- Press and buttons to select the number you want to store as a VIP call.
- Press and hold CALL BACK button () until "VIP" appears on the upper left corner of the display, and a confirmation "beep" tone should be heard to indicate the number has been stored to VIP.
- To cancel the VIP setting, simply press and hold CALL BACK () button until the "VIP" disappears on the display.

To store a number from the Phone Book as VIP

- Press PHONE BOOK button () once followed by arrow buttons to select the number you want to store as a VIP call.
- Press and hold DELETE button (), then press together with CALL BACK () button until the display shows "VIP". A confirmation "beep" tone should be heard to indicate the selected number has been stored to VIP.
- To cancel the VIP setting, simply press and hold DELETE () and CALL BACK () buttons at the same time until the "VIP" disappears on the display.

One-Touch Memory

One-Touch Memory provides you with the easiest way to make a call to a frequently used number.

Storing a phone Number

- Enter the Number with receiver on hook.
- Press and hold the One-Touch Memory button (**M1...M3**), until the display shows "SAVE OK".

Storing a phone Number out of Phone Book or Caller ID List

- Choose the number you want to store from the Caller ID List or Phone Book by using the arrow key.
- Press and hold the One-Touch Memory button (**M1...M3**), until the display shows "SAVE OK".

Deleting a One-Touch Memory number

- Press the STORE button () once.
- The Display will show "—>".
- Press and hold the One-Touch Memory button (**M1...M3**), until the display shows "SAVE OK".

Dialling a One-Touch Memory number

To make a call with the One-Touch Memory, just press the desired button once (**M1...M3**) and lift the handset, or press the SPEAKER button ().





Notes

The maximum number of digits to be entered is 18. If the number exceeds 18 digits, the display will show "TOO LONG" and the exceeding digits will not be stored.

Two-Touch Memory

Besides the One-Touch Memory, the AGFEO T 15 is also equipped with 10 Two-Touch Memory banks.

Storing a number

- Press STORE button () once and the display shows "--->".
- Enter the desired phone number. You may enter * or # buttons into the dialling sequence just like the way you usually make calls to the desired phone number after you have picked up the handset. If your phone is connected behind a PABX switching system, you may enter a pause by pressing PAUSE button () into the dialling sequence to insert a timed delay when necessary.
- Press STORE button () once again, "--->?" will appear on the display.
- Press a numbered button from **0** to **9** to select a memory bank location until the display shows "SAVE OK". Then press CALL BACK button () twice.

Deleting a number

To delete a number from the Two-Touch Memory, you have to overwrite the Position with a blank.

Dialling a number

To make a call with the Two-Touch Memory, simply press and hold the desired numbered button from **0** to **9** until the display shows the stored number. Then lift the handset or press SPEAKER button (). The number will dial out automatically.





Note

The maximum number of digits to be entered is 18. If the number exceeds 18 digits, the display will show "TOO LONG" and the exceeding digits will not be stored.



Phonebook

The AGFEO T 15 provides you with a built in phone book with 70 Store Positions.



Make a new entry

- Press and hold PHONE BOOK button () for about 3 seconds
- Enter the phone number for the entry (maximum 18 digits). "TOO LONG" will appear on the display if more than 18 digits are entered.
- Press PHONE BOOK button () again to enter the name setting.
- Enter the name by using the alphanumeric keypad, please refer to page 12.
- Press PHONEBOOK button () once to store the entry.
- End programming by pressing DELETE button ().



Copy Caller ID numbers and redial memories to the Phone Book

- Find the number in the Caller ID memory or the redial list.
- Press and hold PHONE BOOK button () for 3 seconds.
- The number will be copied to the Phone Book and the cursor will flash to indicate that you can enter or edit the name (by using the keypad).
- Press PHONE BOOK button () to confirm and to enter the next number.
- Press DELETE button () to exit.



Edit Phone Book Number

- Press PHONE BOOK button () and use the arrow keys to find the desired number.
- Use the arrow keys to view the whole number if the display is not showing your full phone book memory.
- Press CALL BACK button () for 3 seconds.
- Then, the phone enters editing mode and the name can be changed as described in "make a new entry".

Delete an entry

- Press PHONE BOOK button () and use the arrow keys to find the desired number.
- Press DELETE Button (). The display shows "DEL ?".
- Press DELETE button again to confirm and the record can be erased.

Dialling a Phonebook Number

- Press PHONE BOOK button () and use the arrow keys to find the desired number.
- Select a record in the Phone Book.
- Use the arrow keys to view the whole number if the display is not showing your full phone book memory.
- Lift the handset or press SPEAKER button (). The number will be dialled automatically.

Entering Names with Alphanumeric Keypad

The following table shows you which numbered button provides you with the letter you need.

If two continuous letters are on the same key, you need to press CALL BACK button () in between them to insert the second letter.

Press DELETE button () for deleting the prevailing digit.

 Taste	1mal	2mal	3mal	4mal	5mal	6mal	7mal	8mal	9mal	10mal
①	1	.	,	?	!	-	"	'	()
②	A	B	C	a	b	c	2			®
③	D	E	F	d	e	f	3			
④	G	H	I	g	h	i	4			
⑤	J	K	L	j	k	l	5			
⑥	M	N	O	m	n	o	6	...	-	"
⑦	P	Q	R	S	p	q	r	s	7	
⑧	T	U	V	t	u	v	8	ÿ		
⑨	W	X	Y	Z	w	x	y	z	9	
⑩	0	+	&	@	/	\$	%			

Operation of Caller ID

Caller ID shows and records caller's available phone numbers when it rings. Caller ID function only works if your phone line is provided with Caller ID function. In most countries, Caller ID function must be paid and subscribed separately from normal phone function. For details, please consult your phone service provider.

If the caller's number is already stored in the Phone Book, the matched name will be displayed when the phone receives a call. If the number cannot be transmitted, the display will show the text "PRIVATE" (number is suppressed by caller).

When there are new calls, the red indicator will flash. The light will continue to flash until the new calls have been reviewed.

This phone keeps up to 61 records of caller's numbers in the Caller ID memory. As long as the records have not been deleted, they will remain in the memory. When the memory is full, the oldest record will be deleted and replaced by the new one.



View Caller ID memory



Leave the phone on-hook, browse with the arrow buttons. Caller's numbers with matching names, and calling time and date will be shown as you browse through the Caller ID memories. If a new call comes repeatedly, the display will show "+" icon on the upper row of the screen. When the list of the Caller ID memories has reached the end, "END OF LIST" will be shown on the display. Then, press or button to continue.

Make a call from the Caller ID memory

When you are browsing the Caller ID memory as mentioned above, and the caller's number is shown on the display, push SPEAKER button () and the displayed number will be dialled.

Delete a record

When you are browsing the Caller ID memory as mentioned above, and the caller's number is shown on the display, push DELETE button () and the display will show "DEL ?". Press DELETE button () again to confirm the deletion and the displayed number will be deleted accordingly.

If you want to delete all records, press and hold DELETE button () for 6 seconds. The display shows "ALL DEL ?". Press DELETE button () again to confirm. The display shows "NO CALL". Then, press any key to exit the mode.

Declaration of Conformity

EU-Konformitätserklärung

EC-Declaration of Conformity
CE-Déclaration de Conformité

Der Hersteller: AGFEO GmbH & Co. KG

The Manufacturer:
Le Constructeur:

Adresse: Gaswerkstr. 8
D - 33647 Bielefeld

Address:
Adresse:

Erklärt, dass das Produkt: T-15

Declares that the Product:
Declare que le Produit:

Type: a/b Telefon

Model: T-15

Components: -----

die grundlegenden Anforderungen gemäß Artikel 3 der nachstehenden EU-Richtlinien erfüllt:

meets the essential requirements according to article 3 of the following EC-Directive:
est conforme aux exigences essentielles d' article 3 de la Directive CE:

**Richtlinie 1999/5/EG des Europäischen Parlaments und des Rates vom 09. März 1999
über Funkanlagen und Telekommunikationsendeinrichtungen und die gegenseitige
Anerkennung ihrer Konformität**

Directive 1999/5/EC of the European Parliament and of the Council of 09 March 1999 relating to radio and
telecommunications terminal equipment, including the mutual recognition of their conformity
Directive 1999/5/CE du Parlement européen et du Conseil du 09 mars 1999 concernant les radio et équipement terminaux de
télécommunications, incluant la reconnaissance mutuelle de leur conformité

und dass die folgenden harmonisierten Normen angewandt wurden:

and that the following harmonised standards has been applied:
et que les standards harmonisés suivants ont été appliqués:

EN 55022/1998
EN 55024/1998
EN 60950/2000
TBR 21/1998
TBR 38/1998

Bielefeld, 18. November 2002

Ort und Datum der Konformitätserklärung
Place and date of the declaration Lieu et date de la déclaration

Phone : +49(0)5 21 44 70 9-0
FAX : +49(0)5 21 44 70 9-50

Name und Unterschrift
Name and Signature Nom et Signature

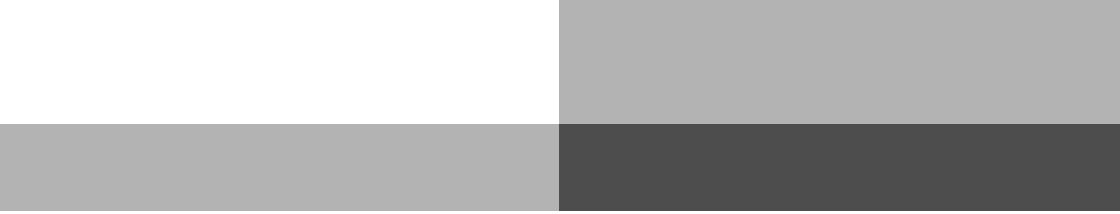

Ident no. 556 246

Subject to change without notice.
No liability can be accepted for
errors contained in this document.

Printed in Germany

0034

AGFEO GmbH & Co. KG

Gaswerkstr. 8

D-33647 Bielefeld

Internet: <http://www.agfeo.de>